

v-protect

fiber optic splice protectors

Heat Shrink Fiber
Optic Splice Protectors

Series V18

TECHNICAL DATA SHEET

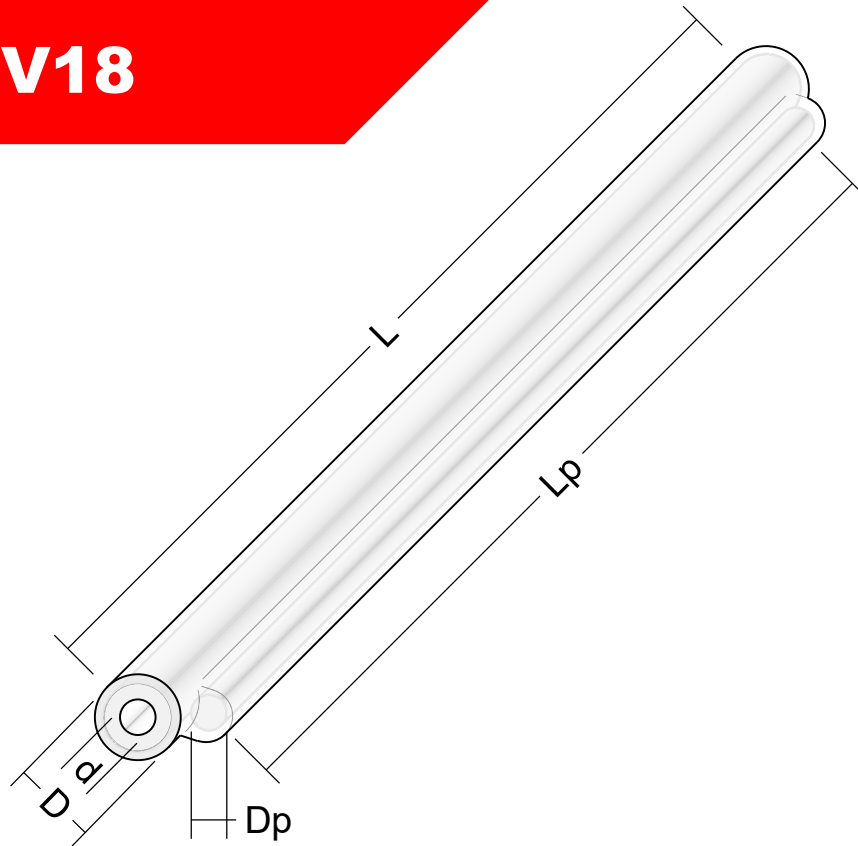

Part no.	D	L	d	Dp	Lp
V18-20-XX	1,8	20	1,2	0,75	20
V18-25-XX	1,8	25	1,2	0,75	21
V18-30-XX	1,8	30	1,2	0,75	26
V18-35-XX	1,8	35	1,2	0,75	31
V18-40-XX	1,8	40	1,2	0,75	36
V18-45-XX	1,8	45	1,2	0,75	41
V18-50-XX	1,8	50	1,2	0,75	46
V18-55-XX	1,8	55	1,2	0,75	51
V18-60-XX	1,8	60	1,2	0,75	56
V18-61-XX	1,8	61	1,2	0,75	57

All dimensions in mm. Other lengths are available on request.

D – Outer diameter after recovery
L – Length after recovery
d – Hole diameter before recovery
Dp – Pin diameter
Lp – Pin length
XX – Color

AVAILABLE COLORS

00 – transparent

SOLID COLORS

01 – black 07 – blue
02 – brown 08 – purple
03 – red 09 – grey
04 – orange 10 – white
05 – yellow 11 – pink
06 – green 12 – turquoise

TRANSPARENT COLORS

51 – black 57 – blue
52 – brown 58 – purple
53 – red 59 – grey
54 – orange
55 – yellow 61 – pink
56 – green 62 – turquoise

P. (+48) 789 390 230

office@v-protect.com

www.v-protect.com

Series V18

Heat Shrink Fiber Optic Splice Protectors

V18 SPEED series sleeves were constructed to meet the requirements of telecommunication systems' integrators, making use of solutions with a large density of connections. Small size and quickness of assembly are the main advantages of this solution. Excellent climatic and thermal properties make it ideal for use in closed as well as open spaces. The main goals during design phase were: full protection of the fiber optic splices, small size after recovery and short assembly time. Initial shrinking of the outer tube was taken into account during the production process to reduce the gap between the tubes.



This protects the internal tube and Pin from falling out as well as facilitates entering the optical fiber to hole. The final product is checked to meet the requirements set by the EN 50411-3-3 European Standard and GR-1380-CORE American Standard and ZN-96TPSA-006 standard of Polish Telecommunications. The sleeves we produce offer full protection to the fiber optic splices. They do not cause additional insert losses, and they offer protection against mechanical damage, pollution and weather conditions.

V18 series is characterized by small external diameter ($D=1.8\text{mm}$ after recovery), reduced length (the shortest $L=20\text{mm}$), quickness of assembly (below 40s). The sleeve consist of: a 0.75mm diameter PIN, a thin external tube and an internal tube with a 1.2mm hole. The protectors are dedicated to primary coated $250\mu\text{m}$ (fiber) or secondary coated $900\mu\text{m}$ (buffer). The internal tube is made from special material with good adhesion to many materials and low solubility in water. It changes its consistency to semi-liquid in growth temperatures. It enables to eliminate air bubbles through filling up the spaces between the external tube, the Pin and fiber optic cable. The Pin that stiffens the splice is made from steel with a heat extensibility indicator identical to that of an optical fiber. This prevents from longitudinal stresses on the splice during heating process. Longitudinal stresses of the splice influence on growth an insert loss and a reflection loss. In extreme cases they may cause breaking the connection, which makes it necessary to repeat the splice procedure. External tube material guarantees sustainability and resistance to stretching and puncture. It offers optimal air permeability, high gloss and smooth surface.

▣ Properties

- » Outer diameter after recovery: $1,8\text{mm} \pm 0,2\text{mm} *$
- » Hole diameter before recovery: $1,2\text{mm} \pm 0,1\text{mm} *$
- » Length of the protector after recovery: $L \pm 2/-1\text{mm} *$
- » Pin diameter: $0,75\text{mm}$
- » Minimum installation temperature: $110\text{ }^\circ\text{C}$
- » Max installation time: 60 sekonds
- » Standard color: transparent
- » RoHS compliant
- » Packing: 100pcs packed to one zip-bag (other packing method are available on request)

* – Tolerances in accordance with the requirements of EN 50411-3-3

▣ Application

- » Fiber Optic Solution
- » Telecommunication, INTERNET
- » CATV, Cable TV, Monitoring
- » Industry
- » LAN, MAN, WAN, FTTx

Series V18

Heat Shrink Fiber Optic Splice Protectors

▣ Packing

- » The carton contains 1000 pcs fiber optic splice protectors. Standard packing consists of 10 zip bags with 100pcs of protectors each.

Other packaging methods are available on request.



▣ Environmental Specification

- » Storage temperature and humidity: from - 40 to +60°C, from 0 to 95%RH
- » Transport temperature and humidity: from - 40 to +80°C, from 0 to 95%RH
- » Installation temperature and humidity: from - 40 to +90°C, from 0 to 95%RH (no dew)
- » Operation temperature and humidity (after shrink): from - 55 to +105°C, from 0 to 95%RH

▣ References

Protectors meet the requirements of the following standards:

EN 50411-3-3 European standard:

- » Criterion 8.3.1: EN 61300-3-3; Change in attenuation: 1310&1550nm δ IL $\leq \pm 0,1$ dB per circuit of 5 protected fusion splices
- » Criterion 8.3.3: EN 61300-1-1; Vibration: 10-50Hz, amplitude 0,75mm, 15 cycles, 1550nm δ IL $\leq \pm 0,2$ dB durin -, δ IL $\leq \pm 0,1$ dB after - per circuit of 5 protected fusion splices
- » Criterion 8.3.5: EN 61300-2-5, Torsion: magnitude of load 2N, rotation angle +/- 180°, 10 cycles, 1310&1550&1625nm δ IL $\leq \pm 0,1$ dB after - per circuit of 5 protected fusion splices,
- » Criterion 8.3.6: EN 61300-2-4, Fiber/Cable retention: magnitude of load 2N, 60s, 1 cycle, 1310&1550&1625nm δ IL $\leq \pm 0,1$ dB after - per circuit of 5 protected fusion splices,
- » Criterion 8.3.7: EN 61300-2-7, Bending: magnitude of load 2N, 5s, 1 cycle, 1310&1550&1625nm δ IL $\leq \pm 0,1$ dB after - per circuit of 5 protected fusion splices,
- » Criterion 8.3.8: EN 61300-2-17, Cold: -40°C, 96h, 1310&1550nm δ IL $\leq \pm 0,2$ dB durin -, δ IL $\leq \pm 0,1$ dB after - per circuit of 5 protected fusion splices
- » Criterion 8.3.9: EN 61300-2-18, Dry heat: +80°C 96h, 1310&1550nm δ IL $\leq \pm 0,2$ dB durin -, δ IL $\leq \pm 0,1$ dB after - per circuit of 5 protected fusion splices
- » Criterion 8.3.10: EN 61300-2-19, Damp heat: from +25°C to +55°C, 93%Rh, 4 cycles, 96h 1310&1550nm δ IL $\leq \pm 0,2$ dB durin -, δ IL $\leq \pm 0,1$ dB after - per circuit of 5 protected fusion splices
- » Criterion 8.3.11: EN 61300-2-22, Change of temperature: from -40°C to +70°C, 12 cycles, 68h, 1310&1550nm δ IL $\leq \pm 0,2$ dB durin -, δ IL $\leq \pm 0,1$ dB after - per circuit of 5 protected fusion splices
- » Criterion 8.3.12: EN 61300-2-26; Salt mist: concentration NaCl 5%, +35°C 96h 6.5÷7.2PH, 1 cycle, 1310&1550&1625nm δ IL $\leq \pm 0,1$ dB after - per circuit of 5 protected fusion splices, additionally, there are no noticeable significant differences in the appearance of the tested product, such as traces of rust, discoloration, deformation.